



melano

jewelry

Dealerbook
Spring Summer '24

INDEX

- Warranty and returns
- Introduction
- Twisted
- Friends
- Vivid
- Kosmic

INDEX ICONS

NL **KLEUR PLATING**
FR **COULEUR PLATING**
EN **PLATING COLOUR**
DE **BESCHICHTUNGSFARBE**

MATERIALEN
MATÉRIAUX
MATERIALS
MATERIALIEN

EXTRA INFORMATIE
INFORMATIONS SUPPLÉMENTAIRES
ADDITIONAL INFORMATION
ZUSÄTZLICHE INFORMATIONEN

 silver

 rose gold

 gold

 silver - gold

 silver - rose gold

 gold - silver

 rose gold - silver

 gold - gold

 silver - silver

 925 sterling silver

 stainless steel

 gemstone

 while stock lasts (30% discount)

WARRANTY AND RETURNS

This dealer book contains our updated warranty terms. Please review them carefully so that you can properly inform your customers. From the moment of purchase we offer 24 months warranty on manufacturing defects of our jewelry and 6 months on the plating of our jewelry. We also like to give some tips to enjoy your Melano items as long as possible.

A. WARRANTY CONDITIONS

Warranty only applies if the jewelry is delivered in a repair bag including a clear indication of the problem and the proof of purchase.

1. Conditions covered by 24-month warranty:

Breakage of the jewelry due to a manufacturing defect except breakage of zirconia and/or gemstones;

- A broken clasp of a bracelet or necklace;
- A bad fit or loss of the setting due to bad production;
- The loss of a stone from the setting due to a manufacturing defect.

2. Conditions covered by 6-month warranty:

Tarnishing and/or discoloration of the plating, when the instructions for use have been observed and there is no improper use.

3. Not covered by warranty:

- No proof of purchase is present;
- Items have been sold at an outlet price;
- Discolouration to the plating due to high acidity of the skin or bad thread;
- Jewelry that has been adapted and/or repaired by persons other than Melano employees;
- Lost or stolen jewelry;

We cannot guarantee that every stone on every piece of jewelry can be fixed in the same position.

B. USER INSTRUCTIONS

To enjoy the Melano items as long as possible, we ask you to follow these user instructions:

- Clean the jewelry only with a clean soft cloth;
- Take off your rings, when you wash your hands;
- For jewelry with a screw-thread, tighten the setting on a daily basis and check whether the rubber ring is still on the screw-thread. Replacement rubbers are available through our customer service;
- Avoid contact with (hard) surfaces to avoid scratches and dents;
- Avoid contact with chemicals such as hairspray, perfume, body lotion, soap, detergents, shower gel or products containing chlorine. Do not wear the jewelry while swimming, brushing, showering or in similar situations.

What to do when the consumer qualifies for the guarantee?

When you approve the warranty we would like to ask you to replace the product. If you do not have a replacement product in stock, please send the product to us as soon as possible. We will handle the defect within 5 working days;

Please make sure the product is in a repair bag including a clear indication of the problem and the proof of purchase. Repair bags can be ordered for free on the dealer portal or through our customer service department;

Shipping costs are at your own expense. To minimize loss, please use a bubble envelope. Melano cannot be held responsible for the loss of a shipment;

Or choose to give the filled repair bag to your account manager during a visit;

Melano has the right to refuse warranties when the warranty conditions are not met;

The replacement item will be shipped to you with your next order.

C. CREDITING

Warranty cases are always replaced with a new product and therefore never credited;

If the warranty case involves an item from the current collection, it will be replaced with the same item;

If the warranty case is an item from the outlet collection, it will not be credited or replaced;

If it involves an outlet item which can be shown, by means of a receipt, to have been sold at the regular recommended price, it will be replaced by the same item, even if this means that this item is currently part of the outlet collection. In all other outlet cases, no refunds will be made warranty orders will be sent with the next order

D. QUESTIONS OR REMARKS

If you have a question or comment about an item, our website or our service, please contact us:

hello@melano-jewelry.com.

You can also call us on **+31 (0)85-744 1717** on working days (monday - friday) from 9:00 am to 5:00 pm.

For other languages (Dutch, German or French) visit our website www.melano-jewelry.com

INLEIDING

NL

Melano Jewelry is een familiebedrijf uit het Zuiden van Nederland met een internationaal karakter. Al sinds 2004 voeren we de boventoon en blijven we zoeken naar innovaties en creatieve ontwerpen. Elke vrouw kan haar eigen unieke sieraden set samenstellen door al onze steentjes en sieraden te mixen & matchen, passend bij haar stijl, mood en de gelegenheid. Al onze sieraden zijn gemaakt van stainless steel en een eventuele goud- of rose goudkleurige plating, met uitzondering van onze 925 sterling zilveren Fine collections. **Melano Jewelry is hét sieradenmerk voor de vrouw die haar eigen draai aan een dagelijkse look wil geven.**

INTRODUCTION

EN

Melano Jewelry is a family business from the south of the Netherlands with an international character. Since 2004 we lead the way and keep looking for innovations and creative designs. Every woman can create her own unique jewelry set by mixing & matching all our colorful stones and jewelry to suit her style, mood and the occasion. Our jewelry is made of stainless steel and an optional gold or rose gold plating, with the exception of our 925 sterling silver Fine collections. **Melano Jewelry is the fun jewelry brand for women who want to give their own twist to an everyday look.**

PRÉFACE

FR

Melano Jewelry est une entreprise familiale du sud des Pays-Bas à caractère international. Depuis 2004, nous ouvrons la voie et sommes toujours à la recherche d'innovations et de conceptions créatives. Chaque femme peut créer sa propre parure unique en mélangeant et en assortissant toutes nos pierres colorées et nos bijoux en fonction de son style, de son humeur et de l'occasion. Nos bijoux sont fabriqués en acier inoxydable et tout plaquage or ou or rose, à l'exception de nos collections Fine en argent sterling 925. **Melano Jewelry est la marque de bijoux amusante pour la femme qui veut donner sa propre touche à un look quotidien.**

VORWORT

DE



Melano Jewelry ist ein Familienunternehmen aus dem Süden der Niederlande mit internationalem Charakter. Seit 2004 sind wir tonangebend und immer auf der Suche nach Innovationen und kreativen Designs. Jede Frau kann sich ihr eigenes, einzigartiges Schmuckset zusammenstellen, indem sie all unsere farbenfrohen Steine und Schmuckstücke passend zu ihrem Stil, ihrer Stimmung und dem Anlass mischt und kombiniert. Unser Schmuck besteht aus Edelstahl und einer optionalen Gold- oder Roségoldbeschichtung, mit Ausnahme unserer 925er Sterling Silber Fine Kollektionen. **Melano Jewelry ist die trendige Schmuckmarke für Frauen, die ihrem Alltagslook einen eigenen Twist geben möchten.**

Any questions? ✉ info@melano-jewelry.com ☎ +31 (0)46 426 17 17



Looking for inspiration? 📷 [@melanojewelry](https://www.instagram.com/melanojewelry) 📘 [melanojewelry](https://www.facebook.com/melanojewelry) 📺 [Melano Jewelry](https://www.youtube.com/MelanoJewelry)

Lifestyle items

STORAGE

	NAME & ART. CODE	RRP	EXTRA INFO
	Collector's Box VERZAMELBOX	€ 15,-	Jewelry excluded
	Jewelry Box COLLECTION BOX 2	€ 50,-	Jewelry excluded
	Kosmic Travel Etui KOSMIC TRAVEL ETUI LUXE	€ 50,-	Jewelry excluded

PERFUME

	NAME & ART. CODE	RRP	EXTRA INFO
	Perfume PARFUM TWISTED	€ 25,-	
	Perfume PARFUM VIVID	€ 25,-	
	Perfume PARFUM GLOBE	€ 25,-	

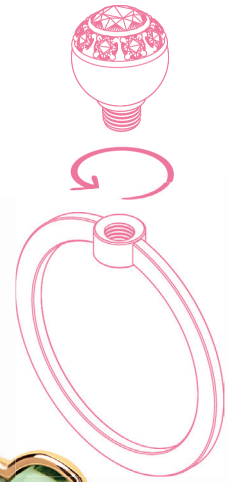

Twisted

Stainless steel
Screw system 2,5 mm





















"Refined, contemporary and sophisticated. Put together the most beautiful creations for the sophisticated modern woman!"







TWISTED STARTER SET

	NAME & ART. CODE	WIDTH	RRP	SIZE (mm)	PLATING/MATERIAL	STONE COLOURS / PIECES	EXTRA INFO
	Twisted Set MS 0084 TW	4 mm	€ 35,-	48 - 64	△ ● ● ●	incl. 1 stone  PINK	Tracy ring & Basic CZ stone (5012)



TWISTED RINGS

	NAME & ART. CODE	WIDTH	RRP	SIZE (mm)	PLATING/MATERIAL	STONE COLOURS / PIECES	EXTRA INFO
	Petite TR15	1 mm	€ 20,-	48 - 64	△ ● ● ●		
	Tracy M01R 5010	4 mm	€ 22,50	48 - 64	△ ● ● ●		
	Tatum M01R 5090	4 mm	€ 22,50	48 - 64	△ ● ● ●		
	Tiem TR36	2 mm	€ 25,-	48 - 64	△ ● ● ●		
	Trix TR33	4,5 mm	€ 25,-	48 - 64	△ ● ● ●		
	Tessa TR34	5 mm	€ 27,50	48 - 64	△ ● ● ●		
	Tari TR35	5 mm	€ 30,-	48 - 64	△ ● ● ●		
	Tola TR37	4 mm	€ 30,-	48 - 64	△ ● ● ●		
	Tova TR27	4 mm	€ 30,-	48 - 64	△ ● ● ●		
	Tula TR29	1,8 mm	€ 32,50	48 - 64	△ ● ● ●	16 stones  PINK  CHAMPAGNE  LAVENDER	
	Crystal TR17	2,5 mm	€ 32,50	48 - 64	△ ● ● ●	10 stones  CRYSTAL	
	Talía TR32	4 mm	€ 35,-	48 - 64	△ ● ● ●		
	Tori TR28	11 mm	€ 35,-	48 - 64	△ ● ● ●		
	Tana TR30	6 mm	€ 35,-	48 - 64	△ ● ● ●		





TWISTED RINGS

	NAME & ART. CODE	WIDTH	RRP	SIZE (mm)	PLATING / MATERIAL	STONE COLOURS / PIECES	EXTRA INFO
	Flat basic CZ TR19	8 mm	€ 40,-	48 - 64	△ ● ● ●	12 stones  CRYSTAL	
	Trista CZ TR22	7,5 mm	€ 45,-	48 - 64	△ ● ● ●	24 stones  CRYSTAL	
	Tamina CZ TR31	7,5 mm	€ 47,50	48 - 64	△ ● ● ●	25 stones  CRYSTAL	

TWISTED BRACELETS



	NAME & ART. CODE	WIDTH	RRP	SIZE (mm)	PLATING / MATERIAL	STONE COLOURS / PIECES	EXTRA INFO
	Tabora TB14	3,5 mm	€ 45,-	S M L	△ ● ● ●		
	Wave CZ TB15	3,5 mm	€ 65,-	S M L	△ ● ● ●	30 stones  CRYSTAL	

TWISTED EARRINGS



	NAME & ART. CODE	WIDTH	RRP	SIZE (mm)	PLATING / MATERIAL	STONE COLOURS / PIECES	EXTRA INFO
	Tessy TE08	1 mm	€ 25,-	one size	△ ● ● ●		Length: 48 mm
	Stella TE07	1 mm	€ 35,-	one size	△ ● ● ●		Length: 35 mm
	Tedd CZ TE06	7 mm	€ 45,-	one size	△ ● ● ●	 CRYSTAL	







































TWISTED NECKLACES

	NAME & ART. CODE	WIDTH	RRP	SIZE (mm)	PLATING / MATERIAL	STONE COLOURS / PIECES	EXTRA INFO
	Circle TN03	1 mm circle: 16 mm	€ 45,-	one size	△ ● ● ●		Adjustable in length
	Toni TN05	2 mm	€ 45,-	60 cm	△ ● ● ●		

TWISTED PENDANTS

	NAME & ART. CODE	WIDTH	RRP	SIZE (mm)	PLATING / MATERIAL	STONE COLOURS / PIECES	EXTRA INFO
	Tara M01E 5055	3,5 mm	€ 15,-	one size	△ ● ● ●		You will receive a set of 2 pendants, as shown in the image
	Teddy TP06	10 mm	€ 32,50	one size	△ ● ● ●	11 stones  CRYSTAL	















TWISTED STONES

	NAME & ART. CODE	WIDTH	RRP	PLATING / MATERIAL	STONE COLOURS	EXTRA INFO
	Dot TMC5	8 mm	€ 20,-	△ ● ● ●	 PEARL EFFECT CREAM  PEARL EFFECT BRONZE	
	Basic Star TMB1	7 mm	€ 20,-	△ ● ● ●		
	Ball M01SR 5015 M01SR 5016	6 mm 8 mm	€ 20,-	△ ● ● ●		
	Flower TM83	7 mm	€ 20,-	△ ● ● ●		
	Wedge TMC7	10 mm	€ 22,50	△ ● ● ●	 CRYSTAL  CHAMPAGNE  FUCHSIA	
	Glossy TMB8	6 mm	€ 22,50	△ ● ● ●	 CRYSTAL  AMETHYST  ROSE  LIGHT COLORADO TOPAZ  LIGHT ROSE  LIGHT PEACH  BLUE ZIRCON  AQUA BOHEMICA	
	Basic CZ M01SR 5017	4 mm	€ 22,50	△ ● ● ●	 OLIVE  TURQUOISE  JEANS BLUE  MOONSTONE  WHITE  CRYSTAL  AB  MILK PINK  PINK  AUBERGINE  RUBY RED  CHAMPAGNE  SALMON  SMOKED TOPAZ  COFFEE  TR. BLACK  BLACK	















NEW

















TWISTED STONES

	NAME & ART. CODE	WIDTH	RRP	PLATING/MATERIAL	STONE COLOURS	EXTRA INFO	
	Basic CZ M01SR 5011 M01SR 5012	6 mm 8 mm	€ 22,50	△ ○ ● ●	<ul style="list-style-type: none"> OLIVE CHRYSOLE TURQUOISE MONTANA AQUAMARINE JEANS BLUE MOONSTONE TANZANITE 	<ul style="list-style-type: none"> MILK PINK PINK AUBERGINE RUBY RED ORANGE YELLOW SALMON CHAMPAGNE SMOKED TOPAZ COFFEE TR. BLACK BLACK AB CRYSTAL WHITE 	
	Heart TM47	7 mm	€ 22,50	△ ○ ● ●	<ul style="list-style-type: none"> SIAM CRYSTAL FUCHSIA 	<ul style="list-style-type: none"> CHAMPAGNE MILK PINK JEANS BLUE 	
	Cloud TMC4	7 mm 9 mm	€ 22,50	△ ○ ● ●	<ul style="list-style-type: none"> CHAMPAGNE BLACK FUCHSIA TURQUOISE <small>NEW</small> CRYSTAL <small>NEW</small> LIME <small>NEW</small> 	<ul style="list-style-type: none"> COFFEE MONTANA LAVENDER AB <small>NEW</small> MILK PINK <small>NEW</small> 	NEW COLOURS SUMMER ITEM '24 Available from June
	Icicle TMC6	7,5 mm height: 15 mm	€ 22,50	△ ○ ● ●	<ul style="list-style-type: none"> CHAMPAGNE BLACK AZURE 	<ul style="list-style-type: none"> AB LAVENDER 	
	Bulb TM96	8 mm	€ 22,50	△ ○ ● ●	<ul style="list-style-type: none"> CRYSTAL AQUAMARINE CHAMPAGNE TURQUOISE 	<ul style="list-style-type: none"> AB MILK PINK MOONSTONE TR. BLACK 	While stock lasts
	Secured TMD2	10 mm	€ 25,-	△ ○ ● ●	<ul style="list-style-type: none"> MILK PINK TURQUOISE CHAMPAGNE 	<ul style="list-style-type: none"> LIME FUCHSIA 	
	Huggie TMC8	10 mm	€ 25,-	△ ○ ● ●	<ul style="list-style-type: none"> CRYSTAL CHAMPAGNE LAVENDER 	<ul style="list-style-type: none"> PINK LIME 	MOTHER'S DAY '24 Available from April
	Slice TMA4	11 mm	€ 25,-	△ ○ ● ●	<ul style="list-style-type: none"> CRYSTAL CHAMPAGNE BLACK FUCHSIA 	<ul style="list-style-type: none"> COFFEE AUBERGINE MONTANA 	While stock lasts
	Box TMA5	8 mm	€ 25,-	△ ○ ● ●	<ul style="list-style-type: none"> OLIVE CHAMPAGNE BLACK FUCHSIA 	<ul style="list-style-type: none"> COFFEE TR. BLACK MONTANA SALMON 	
	Star TMA9	7 mm	€ 25,-	△ ○ ● ●	<ul style="list-style-type: none"> CRYSTAL CHAMPAGNE BLACK 	<ul style="list-style-type: none"> OLIVE JEANS BLUE 	
	Pearl TM54	5 mm 8 mm 10 mm	€ 25,-	△ ○ ● ●	<ul style="list-style-type: none"> WHITE 		
	Pointy TMA1	6 mm	€ 25,-	△ ○ ● ●	<ul style="list-style-type: none"> CRYSTAL MF AQUAMARINE 	<ul style="list-style-type: none"> CRYSTAL SILVER SHADE BLACK DIAMOND 	
	Pearl Ball M01SR 5080 SS M01SR 5081 G M01SR 5082 RG	6 mm	€ 25,-	△ ○ ● ●	<ul style="list-style-type: none"> WHITE 		
	Spring Fling TMD8	12 mm	€ 27,50	△ ○ ● ●	<ul style="list-style-type: none"> FUCHSIA RED JEANS BLUE 	<ul style="list-style-type: none"> CHAMPAGNE LIME 	

TWISTED STONES

	NAME & ART. CODE	WIDTH	RRP	PLATING/ MATERIAL	STONE COLOURS	EXTRA INFO
NEW	 Gemstone Cloud TMD5 TMD4	7 mm 9 mm	€ 27,50	△ ● ● ● ● ☼	● WHITE JADE ● YELLOW JADE ● CORAL RED ● RHODONITE ● TURQUOISE	
NEW	 Petal TMC9	10 mm	€ 27,50	△ ● ● ● ●	● CRYSTAL ● IRIS ● WHITE OPAL ● CITRUS GREEN ● LIGHT AMBER ● SILK ● DENIM BLUE ● ROSE PEACH	
	 Plaza TMC2	7 mm	€ 27,50	△ ● ● ● ●	● CRYSTAL ● OLIVE ● CHAMPAGNE ● AUBERGINE ● BLACK ● MONTANA	
	 Frozen Star TMC1	8 mm	€ 27,50	△ ● ● ● ●	● CRYSTAL ● OLIVE ● CHAMPAGNE ● PURPLE ● BLACK	
	 Cube TMB2	6 mm	€ 27,50	△ ● ● ● ●	● LIGHT SIAM COMET ● LIGHT ROSE COMET ● CRYSTAL GOLDEN SHADOW ● AQUAMARINE COMET ● CRYSTAL AB	
	 Gemstone Facet Ball TMB4	8 mm	€ 27,50	△ ● ● ● ● ☼	● AMETHYST ● RED LINE AGATE ● TURQUOISE ● WHITE JADE ● HONEY JADE	
	 Ridged TMA7	10 mm	€ 27,50	△ ● ● ● ●	● MONTANA ● AMETHYST IGNITE ● VINTAGE ROSE ● CRYSTAL SILVER SHADE ● CRYSTAL GOLDEN SHADOW	
	 Ball CZ TM94	6 mm	€ 27,50	△ ● ● ● ●	● CRYSTAL ● CHAMPAGNE ● JEANS BLUE	While stock lasts
	 Gradient TMA2	12 mm	€ 27,50	△ ● ● ● ●	● CRYSTAL OCEAN DELITE ● CRYSTAL LAVENDER DELITE ● ROYAL RED DELITE ● ORANGE GLOW DELITE ● ROYAL BLUE DELITE ● LAGUNA DELITE	
	 Glass Drop TM84	8 mm height: 19 mm	€ 27,50	△ ● ● ● ●	● LIGHT OLIVE ● MILK PINK ● JEANS BLUE ● CRYSTAL ● BLACK	
	 Shiny TM74	6 mm 8 mm	€ 27,50	△ ● ● ● ●	● CRYSTAL ● JET BLACK ● AQUAMARINE ● LIGHT ROSE ● MONTANA ● LIGHT COLORADO TOPAZ ● SMOKED TOPAZ	
	 Facet Bold TM52	10 mm 12 mm	€ 27,50	△ ● ● ● ●	● ROSE ● CRYSTAL ● MIDNIGHT ● JET BLACK ● CRYSTAL GOLDEN SHADOW	
	 Halo CZ TM67	10 mm	€ 27,50	△ ● ● ● ●	● CRYSTAL CELSIAN ● LIGHT SAPPHIRE ● CHRYSOLITE ● WHITE OPAL ● JONQUIL AB ● CRYSTAL ● LIGHT ROSE	
	 Gemstone Plate TM62	12 mm	€ 27,50	△ ● ● ● ● ☼	● SODALITE ● ONYX ● AMAZON ● HOWLITE ● RHODONITE ● PICTURE JASPER ● ROSE QUARTZ ● TIGEREYE	While stock lasts
	 Gemstone Cilinder TM65	5 mm height: 20 mm	€ 27,50	△ ● ● ● ● ☼	● SODALITE ● ONYX ● AMAZON ● HOWLITE ● RHODONITE ● PICTURE JASPER ● ROSE QUARTZ ● TIGEREYE	

TWISTED STONES

	NAME & ART. CODE	WIDTH	RRP	PLATING/MATERIAL	STONE COLOURS	EXTRA INFO
	Gemstone Ball TM72	8 mm 12 mm	€ 27,50	△ ● ● ● ● ☁	AMAZON RHODONITE ONYX HOWLITE PICTURE JASPER	12 mm While stock lasts
	Cushion TM91	10 mm	€ 27,50	△ ● ● ● ●	GRAPHITE AQUAMARINE GOLDEN SHADOW VINTAGE ROSE SHIMMER CRYSTAL	
	Butterfly TMB3	9,5 mm	€ 30,-	△ ● ● ● ●	CRYSTAL JEANS BLUE AMETHYST CRYSTAL AB LIGHT ROSE CR SILVER NIGHT	
	Coral TMD1	10 mm	€ 30,-	△ ● ● ● ●	CRYSTAL CHAMPAGNE JEANS BLUE PINK FUCHSIA	
	Bali Facet TMB7	10 mm	€ 30,-	△ ● ● ● ●	CHAMPAGNE FUCHSIA JEANS BLUE TURQUOISE LAVENDER CHRYSOLEITE	
	Baguette TMA3	11 mm	€ 30,-	△ ● ● ● ●	CRYSTAL CHAMPAGNE BLACK OLIVE AUBERGINE MONTANA	
	Crystal Pearl TM77	10 mm	€ 30,-	△ ● ● ● ●	WHITE BRONZE	
	Brilliant CZ TM61	12 mm	€ 32,50	△ ● ● ● ●	BLACK DIAMOND AMETHYST IGNITE LIGHT AMETHYST LIGHT SAPPHIRE DARK INDIGO LIGHT COLORADO TOPAZ CRYSTAL BLUE ZIRCON RED VELVET LIGHT PEACH	
	Vintage CZ TMB9	14 mm	€ 35,-	△ ● ● ● ●	CRYSTAL BLACK	
	Circular TMB5	12,5 mm	€ 35,-	△ ● ● ● ●	CRYSTAL OCEAN DELIGHT WHITE OPAL CRYSTAL IVORY CREAM CRYSTAL SILVER NIGHT SMOKED AMBER CRYSTAL GOLDEN SHADOW CRYSTAL PURPLE CRYSTAL MAROON CRYSTAL SILSAGE CRYSTAL SKY VINTAGE ROSE	
	Ribbed CZ TMA6	10,5 mm	€ 35,-	△ ● ● ● ●	CRYSTAL CHAMPAGNE BLACK COFFEE AUBERGINE MONTANA FUCHSIA	While stock lasts
	Pumpkin TMA8	12 mm	€ 35,-	△ ● ● ● ● ☁	WHITE JADE ROSE QUARTZ RED AVENTURINE AVENTURINE	While stock lasts
	Allure TMB6	8 mm	€ 37,50	△ ● ● ● ●	CHAMPAGNE MILK PINK AQUAMARINE LAVENDER	
	Lush TMC3	12 mm	€ 40,-	△ ● ● ● ●	LAVENDER OLIVE BLACK COFFEE SALMON MONTANA	
	Flash TM90	13 mm	€ 40,-	△ ● ● ● ●	JET BLACK BERMUDA BLUE CRYSTAL PARADISE SHINE LIGHT COLORADO TOPAZ CRYSTAL	





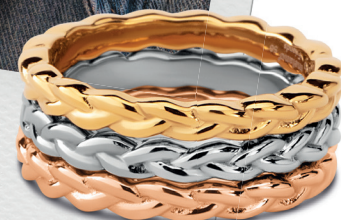
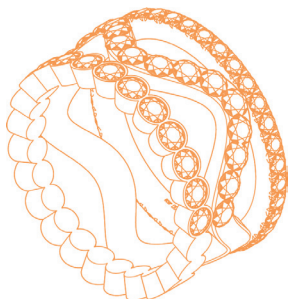







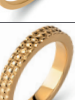

Friends

Stainless steel



"Playful, minimalistic and trendy. Go for a minimalistic look or go all-out and match them with the other collections!"















FRIENDS RINGS

	NAME & ART. CODE	WIDTH	RRP	SIZE (mm)	PLATING/MATERIAL	STONE COLOURS / PIECES	EXTRA INFO
	 Hailey FR46	2 mm	€ 15,-	48 - 64	△ ● ● ●		
NEW	 Amour FR58	1,5 mm	€ 20,-	44 - 64	△ ● ● ●	● CRYSTAL ● RED ● RUBY RED	MOTHER'S DAY '24 Available from April Also available in 44 & 46
	 Ruby FR48	4 mm	€ 20,-	48 - 64	△ ● ● ●		
	 Mini CZ FR24	1,5 mm	€ 20,-	48 - 64	△ ● ● ●	1 stone ● CRYSTAL ● BLACK ● JEANS BLUE ● CHRYSOLITE ● SMOKED TOPAZ ● TANZANITE	
	 Julia FR52	5 mm	€ 22,50	48 - 64	△ ● ● ●		
	 Emmy FR45	3 mm	€ 22,50	48 - 64	△ ● ● ●		While stock lasts
NEW	 Adore FR59	1,5 mm	€ 25,-	48 - 64	△ ● ● ●	● CRYSTAL ● RED ● RUBY RED	MOTHER'S DAY '24 Available from April
NEW	 Jaden FR55	4 mm	€ 25,-	48 - 64	△ ● ● ●		
NEW	 Mimi FR56	3 mm	€ 25,-	48 - 64	△ ● ● ●		
	 Love FR53	2 mm heart: 5 mm	€ 25,-	48 - 64	△ ● ● ●		Multipled
	 Amy FR47	4 mm	€ 25,-	48 - 64	△ ● ● ●		
	 Indy FR42	3 mm	€ 25,-	48 - 64	△ ● ● ●	1 stone ● CRYSTAL	While stock lasts
	 Zoey FR43	4 mm	€ 25,-	48 - 64	△ ● ● ●		
	 Evy FR50	2,5 mm	€ 27,50	48 - 64	△ ● ● ●	1 stone ● CRYSTAL ● BLACK ● SMOKED TOPAZ	
	 Saddy FR39	2,5 mm	€ 27,50	48 - 64	△ ● ● ●	12 stones ● CRYSTAL ● CHAMPAGNE ● OLIVE	
	 Sadé CZ FR17	2 mm	€ 27,50	48 - 64	△ ● ● ●	Number of stones vary by size. ● CRYSTAL ● BLACK	













FRIENDS RINGS

	NAME & ART. CODE	WIDTH	RRP	SIZE (mm)	PLATING/MATERIAL	STONE COLOURS / PIECES	EXTRA INFO
	 Amelia FR57	3 mm	€ 30,-	48 - 64	   	11 stones  CRYSTAL  CHAMPAGNE  LAVENDER	
	 Mia CZ FR51	4,5 mm	€ 30,-	48 - 64	   	5 stones  CRYSTAL	
	 Elisa FR49	4 mm	€ 30,-	48 - 64	   		
	 Sophie FR44	2 mm	€ 30,-	48 - 64	   	Number of stones vary by size  CRYSTAL	
	 Ilja FR54	9 mm	€ 37,50	48 - 64	   	Number of stones vary by size  CRYSTAL	

FRIENDS BRACELETS

	NAME & ART. CODE	WIDTH	RRP	SIZE	PLATING/MATERIAL	STONE COLOURS / PIECES	EXTRA INFO
	 Liza FB23	3 mm	€ 20,-	S M L	   		
	 Scarlett FB26	5,5 mm	€ 30,-	one size	   	 TURQUOISE  CRYSTAL  LIME  CHAMPAGNE  FUCHSIA  LAVENDER	SUMMER ITEM '24 Available from June
	 Madeline FB24	4 mm	€ 42,50	M L	   	 WHITE	
	 Nadie FB18	4 mm	€ 45,-	S M L	   		
	 Hinged CZ FB18CZ	4 mm	€ 65,-	S M L	   	25 stones  CRYSTAL	













FRIENDS EARRINGS

	NAME & ART. CODE	WIDTH	RRP	PLATING/MATERIAL	STONE COLOURS / PIECES	EXTRA INFO
	 Mila FE40	2 mm	€ 20,-	   		ø: 22 mm
	 Lila FE41	2,5 mm	€ 22,50	   		15 x 22 mm Optional Can be combined with KE02 or KE03

FRIENDS EARRINGS

	NAME & ART. CODE	WIDTH	RRP	PLATING/MATERIAL	STONE COLOURS / PIECES	EXTRA INFO
	Ella FE42	2,5 mm	€ 22,50	△ ● ● ● ●		15 x 15 mm Optional Can be combined with KE02 or KE03
	Mabel CZ FE35	5 mm	€ 30,-	△ ● ● ● ●	<ul style="list-style-type: none">  OLIVE  CHRYSOLITE  TURQUOISE  MONTANA  AQUAMARINE  JEANS BLUE  MOONSTONE  TANZANITE  MILK PINK  PINK  AUBERGINE  RUBY RED  ORANGE  YELLOW  SALMON  CHAMPAGNE  SMOKED TOPAZ  COFFEE  TR. BLACK  BLACK  AB  CRYSTAL  WHITE 	
	Tanya M01E 5080 SS M01E 5081 G M01E 5082 RG	5 mm	€ 30,-	△ ● ● ● ● ●	 WHITE	
	Abigail FE39	7 mm	€ 35,-	△ ● ● ● ●	<ul style="list-style-type: none">  TURQUOISE  CRYSTAL  LIME  CHAMPAGNE  FUCHSIA  LAVENDER 	SUMMER ITEM '24 Available from June
	Annabelle FE12	8 mm 12 mm	€ 35,-	△ ● ● ● ●		Thickness: 2,8 mm
	Danielle FE37	10 mm	€ 45,-	△ ● ● ● ●	<ul style="list-style-type: none">  LIGHT COLORADO  CRYSTAL  JET BLACK 	

FRIENDS NECKLACES

	NAME & ART. CODE	WIDTH	RRP	SIZE (cm)	PLATING/MATERIAL	STONE COLOURS / PIECES	EXTRA INFO
	Jodie FN06	1,5 mm	€ 22,50	40 cm 42 cm 44 cm 46 cm 50 cm 80 cm	△ ● ● ● ●		
	Molly FN19	1,5 mm	€ 22,50	40 cm 42 cm 44 cm 46 cm 50 cm 80 cm	△ ● ● ● ●		
	Kamille KN02	2,5 mm	€ 27,50 € 32,50	46 cm 80 cm	△ ● ● ●		Can be combined with pendants with a hole size of at least 3.2 mm
	Lizzy FN20	2 mm	€ 30,-	42 cm	△ ● ● ● ●		
	Layla FN23	5,5 mm	€ 35,-	45 cm	△ ● ● ● ●	<ul style="list-style-type: none">  TURQUOISE  CRYSTAL  LIME  CHAMPAGNE  FUCHSIA  LAVENDER 	SUMMER ITEM '24 Available from June
	Olivia FN22	4,5 mm	€ 65,-	45 cm till 90 cm	△ ● ● ● ● ●		Multiplated options available
	Maeve FN21	4 mm	€ 75,-	47 cm	△ ● ● ● ●		

Vivid

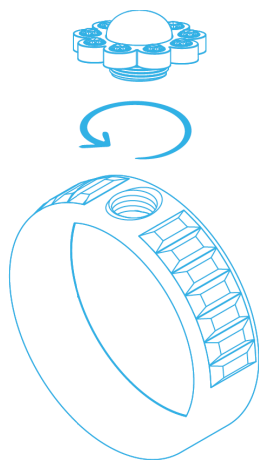

Stainless steel

Screw system 4 mm























*"Tough, robust and fearless.
A robust line designed for strong women!"*



VIVID STARTER SET

	NAME & ART. CODE	WIDTH	RRP	SIZE (mm)	PLATING/MATERIAL	STONE COLOURS / PIECES	EXTRA INFO
	Vivid Set MS 0084 VI	4 mm	€ 35,-	48 - 64	△ ● ● ●	incl. 1 stone  PINK	Vicky ring & Basic CZ stone (9012)



VIVID RINGS

	NAME & ART. CODE	WIDTH	RRP	SIZE (mm)	PLATING/MATERIAL	STONE COLOURS / PIECES	EXTRA INFO
	Vivé VR23	2 mm	€ 20,-	48 - 64	△ ● ● ●		
	Vicky M01R 9010	6 mm	€ 22,50	48 - 64	△ ● ● ●		
	Vie VR24	8 mm	€ 30,-	48 - 64	△ ● ● ●		
	Valeria VR25	5 mm	€ 30,-	48 - 64	△ ● ● ●		
	Victoria VR16	8 mm	€ 30,-	48 - 64	△ ● ● ●		
	Vallée VR18	6 mm	€ 30,-	48 - 64	△ ● ● ●		
	Vesper VR31	8 mm	€ 32,50	48 - 64	△ ● ● ●	1 stone  CRYSTAL	
	Vita VR28	10 mm	€ 35,-	48 - 64	△ ● ● ●		
	Vanity VR27	10 mm	€ 35,-	48 - 64	△ ● ● ●		
	Valetta VR22	11 mm	€ 35,-	48 - 64	△ ● ● ●		
	Venna VR13	15 mm	€ 35,-	48 - 64	△ ● ● ●		
	Vlora VR21	13 mm	€ 40,-	48 - 64	△ ● ● ●		
	Verena CZ VR17	6,5 mm	€ 40,-	48 - 64	△ ● ● ●	14 stones  CRYSTAL	
	Vienne CZ VR29	12 mm	€ 42,50	48 - 64	△ ● ● ●	 CRYSTAL	
	Vicky CZ M01R 9010 CZ	6 mm	€ 50,-	48 - 64	△ ● ● ●	 CRYSTAL	



VIVID BRACELETS

	NAME & ART. CODE	WIDTH	RRP	SIZE (mm)	PLATING/MATERIAL	STONE COLOURS / PIECES	EXTRA INFO
	Hinged CZ VB10	4 mm	€ 65,-	S M L	△ ● ● ●	20 stones	
	Vanilla VB13	4 mm	€ 80,-	S M L	△ ● ● ●	 CRYSTAL	Complete the bracelet with three Vivid stones

























































































VIVID NECKLACES

	NAME & ART. CODE	WIDTH	RRP	SIZE (cm)	PLATING/MATERIAL	STONE COLOURS / PIECES	EXTRA INFO
	Veira VN08	1 mm	€ 45,-	40 cm	△ ● ● ●		
	Vayla VN06	1 mm	€ 45,-	44 cm	△ ● ● ●		
	Vina VN07	1 mm	€ 50,-	44 cm	△ ● ● ●		Complete the necklace with three Vivid stones















VIVID PENDANTS

	NAME & ART. CODE	WIDTH	RRP	SIZE (mm)	PLATING/MATERIAL	STONE COLOURS / PIECES	EXTRA INFO
	Viola VP05	19 mm	€ 22,50		△ ● ● ●		Complete the pendant with two Vivid stones
	Drop VP04	18 mm	€ 22,50		△ ● ● ●		
	Valena VP06	37 mm	€ 37,50		△ ● ● ●		

VIVID STONES

	NAME & ART. CODE	WIDTH	RRP	PLATING/ MATERIAL	STONE COLOURS	EXTRA INFO
	 Heart CZ VM47	10 mm	€ 20,-	△ ● ● ● ●	1 stone  CRYSTAL	
NEW	 Ice Flower VM65	10 mm	€ 22,50	△ ● ● ● ●		
	 Dazzle VM62	12 mm	€ 22,50	△ ● ● ● ●	 CRYSTAL	
	 Basic CZ M01SR 9011 M01SR 9012	5 mm 7 mm	€ 22,50	△ ● ● ● ●	 OLIVE  CHRYSOLITE  TURQUOISE  MONTANA  AQUAMARINE  JEANS BLUE  MOONSTONE  TANZANITE  MILK PINK  PINK  AUBERGINE  RUBY RED  ORANGE  YELLOW  SALMON  CHAMPAGNE  SMOKED TOPAZ  COFFEE  TR. BLACK  BLACK  AB  CRYSTAL  WHITE	
	 No Edge VM25	10 mm	€ 22,50	△ ● ● ● ●	 CRYSTAL CELSIAN  CHRYSOLITE  JONQUIL AB  LIGHT ROSE  LIGHT SAPPHIRE  WHITE OPAL  CRYSTAL	
	 Facet CZ VM39	10 mm	€ 22,50	△ ● ● ● ●	 BLACK  COFFEE  MONTANA  SMOKED TOPAZ  OLIVE	While stock lasts
	 Pave VM49	6 mm	€ 22,50	△ ● ● ● ●	 CRYSTAL  CHAMPAGNE  AB	
NEW Colours	 Boxy CZ VM63	10 mm	€ 25,-	△ ● ● ● ●	 JEANS BLUE  PURPLE  SALMON  TURQUOISE NEW  OCHRE NEW  COFFEE  BLACK  MOONSTONE NEW  FUCHSIA NEW  LIME NEW	NEW COLOURS
	 Pearl M01SR 9080	8 mm	€ 25,-	△ ● ● ● ●	 WHITE	
	 Sunflower VM60	10 mm	€ 27,50	△ ● ● ● ●	 CRYSTAL  BLACK	
	 Cap VM52	9 mm 11 mm	€ 27,50	△ ● ● ● ●	 BLACK DIAMOND  JET HEMATITE  TOPAZ  SMOKED TOPAZ  FUCHSIA	
	 Shiny VM30	10 mm	€ 27,50	△ ● ● ● ●	 CRYSTAL  AQUAMARINE  MONTANA  JET BLACK  LIGHT ROSE  LIGHT COLORADO TOPAZ  SMOKED TOPAZ	
NEW	 Radiant VM66	10 mm	€ 30,-	△ ● ● ● ●	 WHITE OPAL  DENIM BLUE  LIGHT SIAM  CITRUS GREEN  LIGHT ROSE  LIGHT AMBER	
	 Boxy Gem VM61	12 mm	€ 30,-	△ ● ● ● ●	 SODALITE  LIGHT PURPLE JADE  MALACHITE  PICTURE JASPER	



VIVID STONES

	NAME & ART. CODE	WIDTH	RRP	PLATING/ MATERIAL	STONE COLOURS	EXTRA INFO	
	Bali Gemstone VM54	12 mm	€ 30,-	△ ● ● ● ☆	TURQUOISE LAPIS LAZULI	RED AVENTURINE LIGHT PURPLE JADE	
	Bulb Square VM51	12 mm	€ 30,-	△ ● ● ●	OLIVE AB CHAMPAGNE BLACK	SALMON MONTANA FUCHSIA	
	Quadrate VM42	12 mm	€ 32,50	△ ● ● ●	CRYSTAL AQUAMARINE LIGHT TOPAZ SHIMMER	CRYSTAL ASTRAL PINK VITRIL MEDIUM LIGHT COLORADO TOPAZ	
	Shiny square VM43	12 mm	€ 32,50	△ ● ● ●	CRYSTAL MONTANA BLACK	CHRYSOLITE MILK PINK LIGHT COLORADO TOPAZ	
	Joined CZ VM44	14 mm	€ 32,50	△ ● ● ●	CRYSTAL OLIVE CHAMPAGNE LAVENDER	AB PINK FUCHSIA	White stock lasts
	Sice VM45	9 mm	€ 32,50	△ ● ● ●	CRYSTAL CRYSTAL GOLDEN SHADOW VINTAGE ROSE CR. SILVER NIGHT	AMETHYST WHITE OPAL AQUAMARINE	
	Rope VM37	13 mm	€ 32,50	△ ● ● ● ☆	PURPLE GOLDSTONE BROWN GOLDSTONE AMAZONITE RED AVENTURINE	GREEN GOLDSTONE HONEY JADE RHODONITE RED LEOPARD	White stock lasts
	Glam VM67	10 mm	€ 35,-	△ ● ● ●	WHITE MOP		
	Sunny CZ VM69	12 mm	€ 35,-	△ ● ● ●	WHITE MOP		
	Sunny CZ VM70	12 mm	€ 35,-	△ ● ● ●	ABALONE		
	Wildflower VM55	10 mm 12 mm	€ 35,-	△ ● ● ●	CRYSTAL	AB	
	Lined VM56	10 mm	€ 35,-	△ ● ● ● ☆	TURQUOISE LAPIS LAZULI LIGHT PURPLE JADE	HOWLITE JADE RED AVENTURINE	
	Crystal CZ VM53	12 mm	€ 35,-	△ ● ● ●	CRYSTAL OLIVE CHAMPAGNE	BLACK MONTANA FUCHSIA	
	Snowflake CZ VM59	11,5 mm	€ 37,50	△ ● ● ●	CRYSTAL	BLACK	
	Brooch CZ VM58	10 mm	€ 37,50	△ ● ● ●	CRYSTAL	BLACK	

VIVID STONES

	NAME & ART. CODE	WIDTH	RRP	PLATING/MATERIAL	STONE COLOURS	EXTRA INFO
	Blossom VM50	14,5 mm	€ 40,-	△ ● ● ● ●	CRYSTAL CHAMPAGNE	AB BLACK
	Deluxe VM64	12 mm	€ 45,-	△ ● ● ● ●	LIGHT COLORADO TOPAZ IRIS AQUAMARINE NEW SCARLET NEW	CRYSTAL VITRIL MEDIUM CRYSTAL AB CRYSTAL PARADISE NEW CRYSTAL NEW
	Border CZ VM57	10 mm	€ 47,50	△ ● ● ● ● ☁	AMETHYST RHODONITE AMAZONITE HEMATITE MALACHITE	LAPIS LAZULI HONEY JADE RED AVENTURINE BROWN GOLDSTONE PURPLE GOLDSTONE





VIVID EARRINGS

	NAME & ART. CODE	WIDTH	RRP	PLATING/MATERIAL	STONE COLOURS / PIECES	EXTRA INFO
	Vanda VE05	13 mm	€ 35,-	△ ● ● ● ●		You will receive a set of 2, as shown in the image
	Drop VE02	18 mm	€ 35,-	△ ● ● ● ●		You will receive a set of 2, as shown in the image



Vivid Frame collection

VIVID FRAMES

	NAME & ART. CODE	WIDTH	RRP	SIZE (mm)	PLATING/MATERIAL	STONE COLOURS	EXTRA INFO
	 Rose VF06	29 mm	€ 25,-		△ ● ● ●		Only suitable for the Vaya ring MOTHER'S DAY '24 Available from April
	 Sunny Stripe VF01	28 mm	€ 25,-		△ ● ● ●		Only suitable for the Vaya ring
	 Sunny Stripe VF01	36 mm	€ 25,-		△ ● ● ●		Only suitable for the Vaya ring
	 Artistic VF02	36 mm	€ 25,-		△ ● ● ●		Only suitable for the Vaya ring

VIVID FRAMES RINGS

	NAME & ART. CODE	WIDTH	RRP	SIZE (mm)	PLATING/MATERIAL	STONE COLOURS	EXTRA INFO
	Vaya VR26	8 mm	€ 35,-	48 - 64	△ ● ● ●		Can be combined with 1 stone and 1 frame

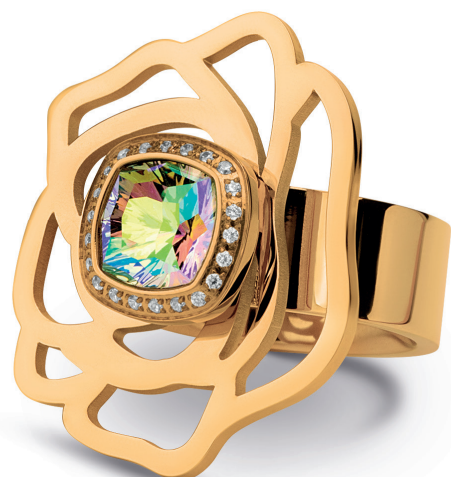

KOSMIC

by melano

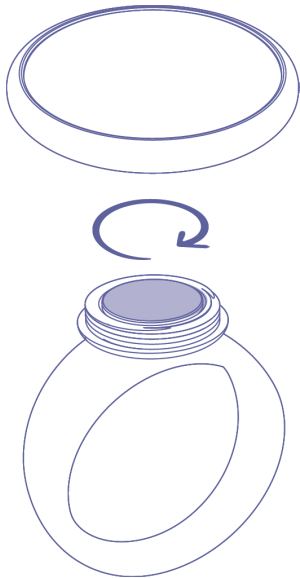

Stainless steel (silver + gold plated)

Screw system 10 mm









"Stylish, artistic and outspoken. You will steal the show with these daring eye-catchers!"

KOSMIC STARTER SET



	NAME & ART. CODE	WIDTH	RRP	SIZE (mm)	PLATING/MATERIAL	STONE COLOURS / PIECES	EXTRA INFO
	Kosmic Set			48 - 64	△ ● ●	incl. 1 stone	Kate ring & Pearl Facet Square stone
	MS 0240 KS	22 mm	€ 85,-			 WHITE MOP	
	MS 0240 KL	28 mm	€ 90,-				Also available in odd sizes

KOSMIC RINGS

	NAME & ART. CODE	WIDTH	RRP	SIZE (mm)	PLATING/MATERIAL	STONE COLOURS / PIECES	EXTRA INFO
	Kore	8 mm	€ 35,-	48 - 64	△ ● ●		Also available in odd sizes
	KR04						
	Kate	8 mm	€ 35,-	48 - 64	△ ● ●		Also available in odd sizes
	KR01						
	Kyra	7,5 mm	€ 110,-	48 - 64	△ ● ●	 SATIN MORODA  GOLDEN SHADOW	Not interchangeable
	KR03					 OCEAN DELITE	

NEW



KOSMIC BRACELETS

	NAME & ART. CODE	WIDTH	RRP	SIZE (cm)	PLATING/MATERIAL	STONE COLOURS / PIECES	EXTRA INFO
	Karen	12,5 mm	€55,-	S M L	△ ● ●		
	KB01						
	Kylie	30 mm	€65,-	S M L	△ ● ●		
	KB02						













KOSMIC PENDANTS

	NAME & ART. CODE	WIDTH	RRP	SIZE (cm)	PLATING/MATERIAL	STONE COLOURS / PIECES	EXTRA INFO
	Khai	12,5 mm	€45,-	one size	△ ● ●		
	KP01						

KOSMIC NECKLACES

	NAME & ART. CODE	WIDTH	RRP	SIZE (cm)	PLATING/MATERIAL	STONE COLOURS / PIECES	EXTRA INFO
	Kamille	2,5 mm	€27,50	46 cm	△ ● ●		Can be combined with pendants with a hole size of at least 3.2 mm
	KN02		€32,50	80 cm			
	Kara	2,5 mm	€65,-	45 cm	△ ● ●		
	KN01						



KOSMIC STONES

	NAME & ART. CODE	WIDTH	RRP	PLATING/ MATERIAL	STONE COLOURS	EXTRA INFO	
	Glamour Disk KM04	24,5 mm	€ 50,-	△ ● ●	CRYSTAL	While stock lasts	
	Gem Disk KM01	28,5 mm	€ 55,-	△ ● ● ☆	RED LEOPARD TURQUOISE LAPIS LAZULI LIGHT PURPLE JADE	HOWLITE PICTURE JASPER ONYX	Natural product, each item may look slightly different
	Abalone Square KM07	22 mm	€ 60,-	△ ● ●	ABALONE		
	Pearl Square KM05	22 mm 28 mm	€ 60,- € 70,-	△ ● ●	WHITE MOP		
	Gem Square KM06	22 mm 28 mm	€ 60,- € 70,-	△ ● ● ☆	TIGEREYE AMAZONITE LIGHT ROSE QUARTZ FOSSIL CORAL	AMETHYST STRIPED AGATE BRONZITE	Natural product, each item may look slightly different
	Bali Square Gem KM20	20 mm	€ 65,-	△ ● ● ☆	PICTURE JASPER CORAL RED AMAZONITE	YELLOW JADE WHITE JADE	
	Flat Gem KM12	28,5 mm	€ 65,-	△ ● ● ☆	GREEN ZEBRA RED PICASSO JASPER	IRON ZEBRA JASPER	Natural product, each item may look slightly different While stock lasts
	Facet Square KM08	22 mm 28 mm	€ 65,- € 75,-	△ ● ●	CRYSTAL CHAMPAGNE FUCHSIA AZURE	BLACK JEANS BLUE LAVENDER	
	Pearl Facet KM09	22 mm 28 mm	€ 65,- € 75,-	△ ● ●	WHITE MOP		
	Gem Eye KM17	37 mm	€ 75,-	△ ● ● ☆	AMAZONITE PICTURE JASPER	YELLOW CALCITE AMETHYST	
	Big Gem Eye KM18	38 mm	€ 80,-	△ ● ● ☆	AMETHYST HOWLITE	RED LEOPARD	MOTHER'S DAY '24 Available from April
	Shaped Facet CZ KM15	35 mm	€ 85,-	△ ● ●	LAVENDER OLIVE	CHAMPAGNE BLACK	
	Framed Facet Square KM14	22 mm	€ 95,-	△ ● ●	CRYSTAL CHAMPAGNE	BLACK	

KOSMIC STONES

	NAME & ART. CODE	WIDTH	RRP	PLATING/MATERIAL	STONE COLOURS	EXTRA INFO
	Shaped Facet Gem KM16	35 mm	€ 95,-	△ ● ● ☼	● LAPIS LAZULI ● BLACK PICASSO JASPER ● TIGEREYE	
	Framed CZ KM11	22 mm	€ 95,-	△ ● ● ☼	● RED LINE AGATE ● SNOWFLAKE OBSIDIAN ● SODALITE ● RHODOCHROSITE ● HOWLITE ● TURQUOISE ● AMETHYST	Natural product, each item may look slightly different
	Shaped Disk KM13	32 mm	€ 95,-	△ ● ● ☼	● AMETHYST ● RED LINE AGATE ● TURQUOISE ● MALACHITE ● FOSSIL CORAL	Natural product, each item may look slightly different
	Crafted Disk KM10	organic shape	€ 100,-	△ ● ● ☼	● RED LINE AGATE ● SNOWFLAKE OBSIDIAN ● SODALITE ● FOSSIL CORAL	Natural product, each item may look slightly different

KOSMIC EARRINGS

	NAME & ART. CODE	WIDTH	RRP	PLATING/MATERIAL	STONE COLOURS / PIECES	EXTRA INFO
	Squared Gem KE02	16 mm	€ 60,-	☼	● ROSE QUARTZ ● TIGEREYE ● AMETHYST ● AMAZONITE ● YELLOW CALCITE	You will receive a set of 2, as shown in the image Can be combined with FE41, FE42 or FE12
	Kamila KE03	16 mm 20 mm	€ 35,- € 40,-		● FUCHSIA ● LAVENDER ● CHAMPAGNE ● AZURE ● JEANS BLUE ● BLACK	You will receive a set of 2, as shown in the image Can be combined with FE41, FE42 or FE12

KOSMIC PENDANT

	NAME & ART. CODE	WIDTH	RRP	PLATING/MATERIAL	STONE COLOURS / PIECES	EXTRA INFO
	Squared Facet KPO2	16 mm	€ 25,-	△ ● ●	● FUCHSIA ● LAVENDER ● CHAMPAGNE ● AZURE ● JEANS BLUE ● BLACK	Can be combined with FN19, FN06 or KN02



ORNAMENTS PENDANTS

NAME & ART. CODE	WIDTH	RRP	SIZE (mm)	PLATING/ MATERIAL	STONE COLOURS / EXTRA INFO
OP01 Pearl	7,5 mm	€ 27,50 / € 32,50	18 karat gold plated / 0,5 micron	<input type="radio"/> Gold <input type="radio"/> Creamrose <input type="radio"/> Peach	White stock lasts
OP02 Bulb	7,5 mm	€ 27,50 / € 32,50	18 karat gold plated / 0,5 micron	<input type="radio"/> Crystal <input type="radio"/> Aquamarine <input type="radio"/> Milk Pink <input type="radio"/> Moonstone <input type="radio"/> Tr. Black	White stock lasts
OP03 Gemstone ball	7,5 mm	€ 27,50 / € 32,50	18 karat gold plated / 0,5 micron	<input type="radio"/> Crystal <input type="radio"/> Picture Jasper <input type="radio"/> Rhodnite <input type="radio"/> Amethyst <input type="radio"/> Onyx <input type="radio"/> Sodalite <input type="radio"/> Howlite	
OP15 Rose	14 mm	€ 32,50 / € 37,50	18 karat gold plated / 0,5 micron	<input type="radio"/> Crystal <input type="radio"/> Amethyst <input type="radio"/> Onyx <input type="radio"/> Sodalite <input type="radio"/> Howlite	NEW
OP11CZ Star CZ	10 mm	€ 32,50 / € 37,50	18 karat gold plated / 0,5 micron	<input type="radio"/> Crystal <input type="radio"/> Amethyst <input type="radio"/> Onyx <input type="radio"/> Sodalite <input type="radio"/> Howlite	
OP10 Sparkling Heart	10 mm	€ 35,- / € 40,-	18 karat gold plated / 0,5 micron	<input type="radio"/> Crystal <input type="radio"/> Amethyst <input type="radio"/> Onyx <input type="radio"/> Sodalite <input type="radio"/> Howlite	
OP12 Flower	11 mm	€ 37,50 / € 42,50	18 karat gold plated / 0,5 micron	<input type="radio"/> Crystal <input type="radio"/> Amethyst <input type="radio"/> Onyx <input type="radio"/> Sodalite <input type="radio"/> Howlite	NEW

CUSTOMISABLE PENDANTS

NAME & ART. CODE	WIDTH	RRP	SIZE (mm)	PLATING/ MATERIAL	EXTRA INFO
OP06 Tag	10x5 mm	€ 27,50 / € 32,50	18 karat gold plated / 0,5 micron	<input type="radio"/> Gold <input type="radio"/> Creamrose <input type="radio"/> Peach	
OP07 Ellipse	10x5 mm	€ 27,50 / € 32,50	18 karat gold plated / 0,5 micron	<input type="radio"/> Gold <input type="radio"/> Creamrose <input type="radio"/> Peach	
OP11 Star	10 mm	€ 32,50 / € 37,50	18 karat gold plated / 0,5 micron	<input type="radio"/> Gold <input type="radio"/> Creamrose <input type="radio"/> Peach	
OP08 Coin	10 mm	€ 32,50 / € 37,50	18 karat gold plated / 0,5 micron	<input type="radio"/> Gold <input type="radio"/> Creamrose <input type="radio"/> Peach	
OP09 Fleur	10 mm	€ 32,50 / € 37,50	18 karat gold plated / 0,5 micron	<input type="radio"/> Gold <input type="radio"/> Creamrose <input type="radio"/> Peach	

1 All customisable pendants can be customised with a **jewelry stamping kit**. For more information please get in touch with your account manager.



Ornaments



925 sterling silver
Bead system



"Expressive, timeless and fascinating. Endlessly expand with a piece of jewelry that you will carry with you forever!"

ORNAMENTS BRACELET



Diamond paperclip
ART. CODE OB01

18 cm
€ 55,- € 75,- € 85,-

21 cm

NAME & ART. CODE	WIDTH	RRP	SIZE (mm)	PLATING/ MATERIAL	STONE COLOURS / PIECES	EXTRA INFO
Diamond paperclip ART. CODE OB01	4,5 mm	€ 55,- € 75,- € 85,-	18 cm	18 karat gold plated	18 karat gold plated	1 micron

ORNAMENTS PENDANTS



Classic Crystal
ART. CODE OP13

8 mm
€ 27,50 € 32,50

14 mm
€ 27,50 € 32,50



18 karat gold plated
0,5 micron



Scallop
ART. CODE OP16

6 mm
€ 27,50 € 32,50

10 mm
€ 27,50 € 32,50



18 karat gold plated
0,5 micron



Teardrop
ART. CODE OP14

10 mm
€ 27,50 € 32,50



18 karat gold plated
0,5 micron



Heart CZ
ART. CODE OP05

6 mm
€ 27,50 € 32,50







18 karat gold plated
0,5 micron

NEW





NEW

NEW





CATEYE EARRINGS

NAME & ART. CODE	WIDTH	RRP	PLATING/ MATERIAL	STONE COLOURS / PIECES	EXTRA INFO
 Carice CE05	6 mm	€ 35,-	 Gold version: 18 karat gold plated 2 micron	All colours included ONYX JADE HOWLITE PICTURE JASPER	You will receive a set, including 8 balls White stock lots
 Clara CE06	12 mm	€ 90,- € 115,-	 Gold version: 18 karat gold plated 2 micron	Including brown Cateye balls	You will receive a set, including the brown Cateye balls

CATEYE BALLS

NAME & ART. CODE	WIDTH	RRP	SIZE (mm)	PLATING/ MATERIAL	STONE COLOURS / EXTRA INFO
 Cateye Ball CM CATEYE	10 mm	€ 5,-	10 mm	AQUA BLACK DARK BLUE DARK PINK PINK LIGHT PURPLE ORANGE	
 Gem Ball CM GEM	10 mm	€ 10,-	10 mm	HOWLITE JADE ONYX ROSE QUARTZ SODALITE	
 CZ Ball CM CZ BALL	10 mm	€ 15,-	10 mm	AB WHITE FUCHSIA OLIVE MILK PINK SALMON TURQUOISE LAVENDER GLITTER COFFEE SMOKED TOPAZ YELLOW	
 Facet CZ Ball CM FACET CZ	10 mm	€ 15,-	10 mm	BLACK CHAMPAGNE SMOKED TOPAZ WHITE DARK RED PINK COFFEE LIME BLUE	
 Special Gem Ball CM SP GEM	10 mm	€ 15,-	10 mm	AMETHYST HEMATITE CORAL PICTURE JASPER RED TIGER EYE	

CATEYE RINGS

NAME & ART. CODE	WIDTH	RRP	SIZE (mm)	PLATING/ MATERIAL	STONE COLOURS / PIECES	EXTRA INFO
 Chrissy CR07	10 mm	€ 75,- € 100,-	48 - 64	⊖ ⊕ ⊗ Gold version: 18 karat gold plated 2 micron	Also available in odd sizes	Including brown Cateye ball
 Charlene CR08	12 mm	€ 75,- € 100,-	48 - 64	⊖ ⊕ ⊗ Gold version: 18 karat gold plated 2 micron	Also available in odd sizes	Including brown Cateye ball
 Cat M01R 3602	6,8 mm	€ 90,- € 125,-	48 - 64	⊖ ⊕ ⊗ Gold version: 18 karat gold plated 2 micron	Also available in odd sizes	Including brown Cateye ball
 Chloe CR09	11 mm	€ 95,- € 120,-	48 - 64	⊖ ⊕ ⊗ Gold version: 18 karat gold plated 2 micron	Also available in odd sizes	Including brown Cateye ball
 Cat CZ M01R 3602 CZ	8 mm	€ 110,- € 145,-	48 - 64	⊖ ⊕ ⊗ Gold version: 18 karat gold plated 2 micron	Also available in odd sizes	40 stones 002 CRYSTAL Including brown Cateye ball

CATEYE NECKLACES

NAME & ART. CODE	WIDTH	RRP	SIZE (mm)	PLATING/ MATERIAL	STONE COLOURS / PIECES	EXTRA INFO
 Carry CN01	47 cm	€ 50,- € 90,-		⊖ ⊕ ⊗ Gold version: 18 karat gold plated 1 micron		

CATEYE PENDANTS

NAME & ART. CODE	WIDTH	RRP	SIZE (mm)	PLATING/ MATERIAL	STONE COLOURS / PIECES	EXTRA INFO
 Chiara CP09	11,5 mm	€ 50,- € 75,-		⊖ ⊕ ⊗ Gold version: 18 karat gold plated 1 micron		Including brown Cateye ball
 Claire CP10	12,5 mm	€ 50,- € 75,-		⊖ ⊕ ⊗ Gold version: 18 karat gold plated 1 micron		Including brown Cateye ball



NEW

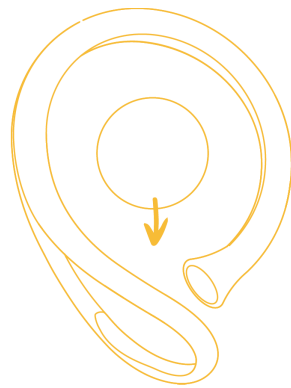
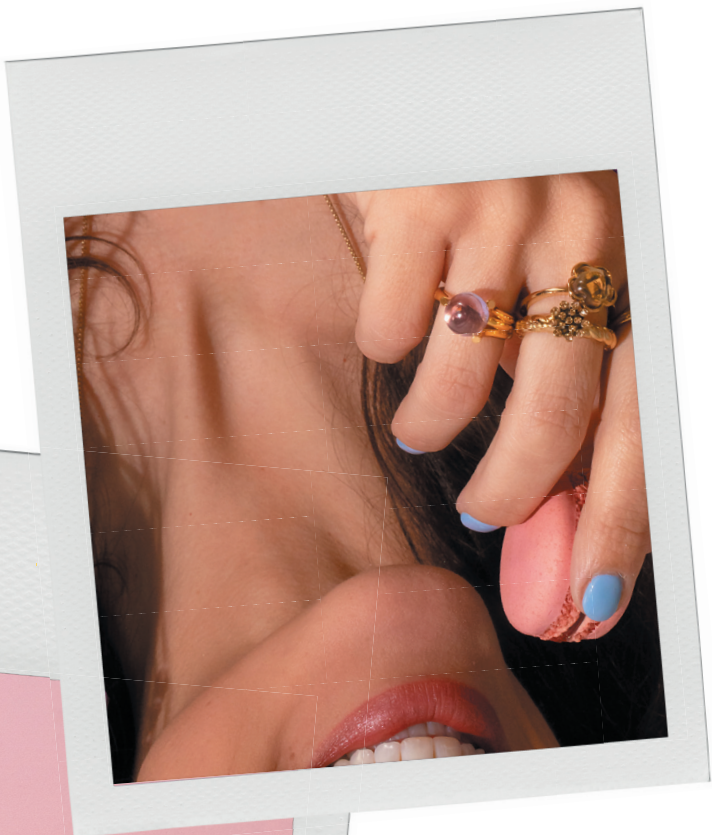

"Gic, fashionable and classy. Choose a different ball every day and add a custom touch to this classic!"



925 sterling silver
Clamp system

Cateye

Any questions?  info@melano-jewelry.com  +31 (0)46 426 17 17

Looking for inspiration?  @melanojewelry  melanojewelry  Melano Jewelry

Wir haben Melano damals mit unserer Cateye-Kollektion gestartet. Eine elegante, modische und klassische Kollektion aus 925 Sterlingsilberschmuck. Jahre später beschlossen wir, unser Angebot an Silberschmuck mit einer komplett neuen Kollektion zu erweitern: Ornaments. Die Ornaments-Kollektion ist eine ausdrucksstarke, zeitlose und faszinierende Linie, die du immer weiter ausbauen kannst. Die Cateye- und die Ornaments-Kollektion bilden zusammen unsere Melano Fine-Kollektion: ein umfangreiches Sortiment 925 Sterlingsilberschmuck, mit oder ohne Vergoldung. Freue dich auf jahrelanges Tragevergnügen und fühle dich wohl mit unserer Fine-Kollektion!

DE VORSTELLUNG FINE-KOLLEKTION

Ensemble, la collection Cateye et la collection Ornaments forment notre collection Melano Fine : une gamme étendue de bijoux en argent sterling, avec ou sans plaquage or. Allez-y pour des années de plaisir à porter et sentez-vous bien avec nos collections Fine!

Nous avons commencé Melano avec notre collection classique : Cateye. Une collection chic, à la mode mais classique, composée exclusivement de bijoux en argent sterling. Des années plus tard, nous avons décidé d'élargir notre gamme de bijoux en argent avec une toute nouvelle ligne : Ornaments. La collection Ornaments est une ligne saisissante, intemporelle et fascinante que vous pouvez constamment élargir.

FR INTRODUCTION FINE COLLECTIONS

Together, the Cateye and Ornaments collections form our Melano Fine collection: an extensive range of sterling silver jewelry, with or without gold plating. Choose for years of wearing pleasure and feel fine with our Fine collections!

We once started Melano with our classic Cateye collection. A chic fashionable collection consisting exclusively of sterling silver jewelry. Years after the Cateye release we decided to expand our range of silver jewelry with a whole new product range called Ornaments. The Ornaments collection is an expressive, timeless and fascinating line that you can expand as you go.

EN INTRODUCTION FINE COLLECTIONS

Samen vormen de Cateye en de Ornaments collectie onze Melano Fine collectie: een uitgebreid assortiment aan sterling zilveren sieraden, met of zonder gouden plating. Ga voor jarenlang draagplezier en feel fine met onze Fine collections!

Ornaments collectie is een sprekende, tijdloze en fascinerende lijn die je alsmaar kunt uitbreiden. We zijn Melano ooit begonnen met onze classic collectie: Cateye. Een chique, modieuze maar toch klassieke collectie bestaande uit uitsluitend sterling zilveren sieraden. Jaren later is er besloten om het aanbod aan zilveren sieraden verder uit te breiden met een geheel nieuwe lijn: Ornaments. De Ornaments collectie is een sprekende, tijdloze en fascinerende lijn die je alsmaar kunt uitbreiden.

NL INTRODUCTIE FINE COLLECTIONS

INDEX

- Introduction
- Cateye
- Ornaments

INDEX ICONS

NL	KLEUR PLATING	● silver
FR	COULEUR PLATING	● gold
EN	PLATING COLOUR	
DE	BESCHICHTUNGSFARBE	
	MATERIALIEN	⊖ 925 sterling silver
	MATÉRIAUX	▽ stainless steel
	MATERIALS	☁ gem stone
	MATERIALIEN	● white stock lasts (30% discount)
EXTRA INFORMATIE		
INFORMATIONS SUPPLÉMENTAIRES		
ADDITIONAL INFORMATION		
ZUSÄTZLICHE INFORMATIONEN		

Dealerbook | Spring Summer '24

collections

Time

melano

